



# Baseline Testing Provides Opportunities for Continuous Improvement

By

**Robert Vaughan, P.Eng. PMP**

Staff Rotating Equipment Engineer  
Shell Global Solutions, Canada

**Wally Bratek, MSc., P.Eng.**

Principal Engineer  
Beta Machinery Analysis

**Michael Hahn, P.Eng.**

Project Manager  
Beta Machinery Analysis

Presented at:

Gas Machinery Conference 2014  
Nashville TN

## Abstract

Continuous improvement is an important philosophy at Shell. For the rotating engineering team, this goal is accomplished by looking at each new facility and finding ways to improve the design, construction, and commissioning process for our rotating equipment.

By examining the results of the baseline vibration testing and past compressor installations, Shell has identified a number of reliability/integrity improvement opportunities for reciprocating compressor packages. Topics include:

- Baseline Testing Approaches
- Piping Tolerances, Fit-up and Field Connections
- Managing Resonance
- Compressor Skid Mounting
- Small Bore Connections to Suction Scrubbers
- Suction Pressure Differential Measurements
- Main Piping and Support Design

This paper outlines these issues, ideas for improvements, and lessons learned.

## Introduction

Shell Canada recently commissioned a large 200 MMSCFD gas plant located in northeastern British Columbia, Canada. The Saturn 1 project included the design, construction, and commissioning of five electric drive 6500 HP KBZ/6 compressor packages. This is the second large scale facility installed in the region, and includes a number of improvements from the first facility. Improvements were also later applied to the Sundance Compressor/Dehy station that has 1680 HP JGK/4 and 840 HP JGK/2 compressors.

BETA Machinery was involved as part of the design team for these facilities, conducted the onsite baseline testing, and supported Shell with the improvement initiative.

Shell's continuous improvement initiative balances the reliability and integrity objectives with the capital and operating cost impacts, as well as practical design and operating impacts. The goal of this paper is to provide insights and opinions from the experiences gained through these continuous improvement initiatives.

The issues and improvements are presented in the following sections:

1. Baseline Testing Approaches
2. Piping Tolerances, Fit-up and Field Connections
3. Managing Resonance
4. Compressor Skid Mounting
5. Small Bore Connections to Suction Scrubbers
6. Suction Pressure Differential Measurements
7. Main Piping and Support Design

# 1. Baseline Testing Approaches

Continuous improvement requires accurate data on which to make informed decisions. The best way to obtain this is through a baseline testing and inspection program. This allows the owner to compare the actual field results with the intended design. How to collect the data, the required scope, and comparing field results to the design model are three issues to address when developing the testing plan.

a. Multichannel (50 to 100+ channels) vs. 2/4 Channel Data Acquisition System:

The testing system must collect a large amount of data to identify the worst case problems for machines operating across different conditions and speeds. Vibration measurements are needed at many locations in the piping system, collected at various conditions/load steps and across the entire speed range. Figure 1 illustrates how forces, and thus vibration, can vary widely based on operating conditions.

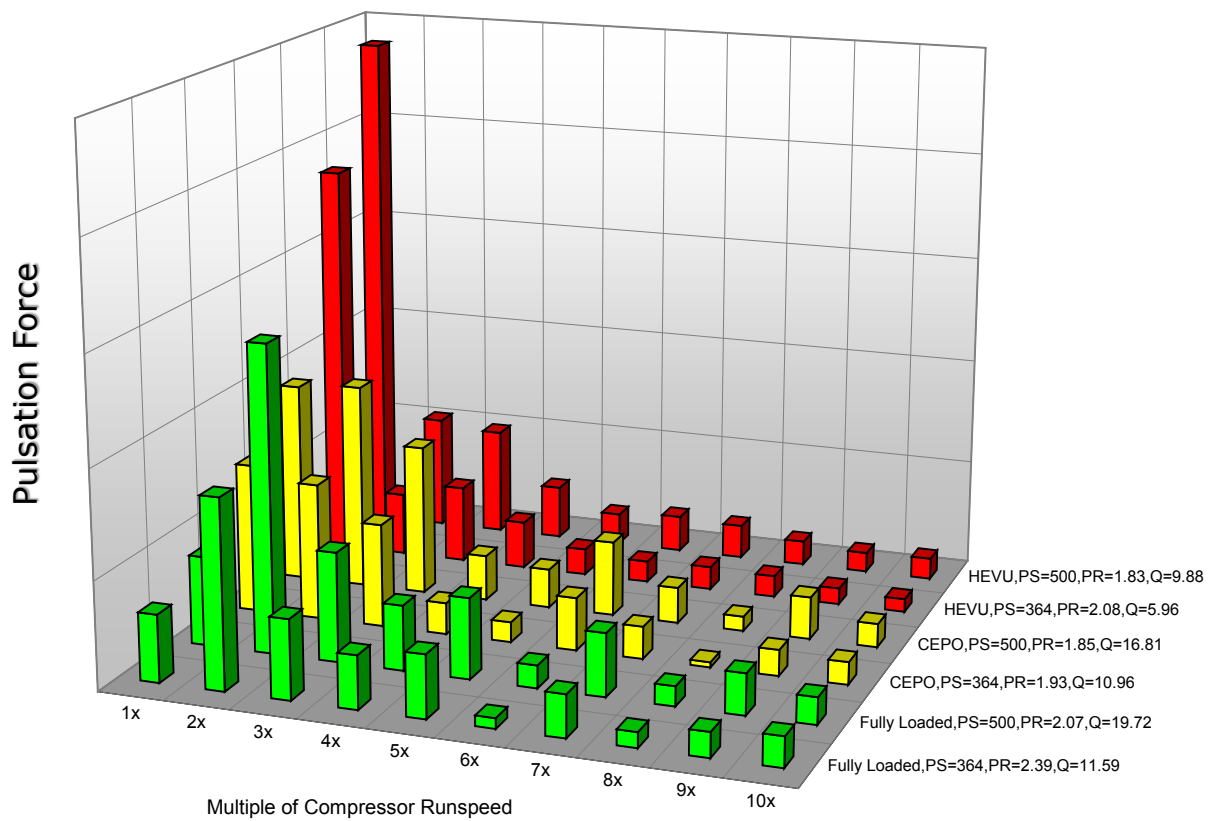

**Figure 1: The Magnitude of Forces and Frequencies Vary by Condition. A Multi-channel data acquisition system can expedite the collection of data across different conditions in order to verify worst case vibration.**

The Advantages [A] and Disadvantages [D] of the 2 approaches are outlined below. For the Shell compressors, the multichannel approach was used based on the advantages below:

- 2 or 4 channel device:
  - D: The tests must be repeated many times to measure vibration at different locations for each condition and run speed sweep. Significantly more field time is required to complete a comprehensive test.
  - A: Lower instrument complexity (easier to set-up).
  - D: It can be difficult to ensure consistency across the multiple tests. This adds challenges to post processing data.
  - D: Typically a longer time to analyze the data (post processing).
- Multi-channel testing:
  - A: Captures 50 to 100+ test points. The unit can be run across a range of conditions and capture the data once – avoiding the need to conduct multiple tests and speed sweeps.
  - A: Longer set-up at site, but overall testing time is less.
  - A: Much easier for testing and less stress on machine as numerous speed sweeps are minimized.
  - A: Better data for comparison.

**Recommendation:** Multi-channel testing has many advantages for baseline testing



Figure 2: Multi-channel data acquisition system

- b. Confusion on the required scope and guideline for baseline testing and inspection program:
- It is common for customers to focus on the compressor and vessels on the skid and forget to measure other important risk areas. For a large unit, the onsite testing time will range between one and two days depending on the facility.
  - Agree on the vibration screening guideline.
  - Suggested scope:
    - Confirm pulsations match expected values
    - Check vibration and resonance in main piping, skid, frame – across run speed for key operating conditions and load steps
    - Check on-skid small bore and pressure safety valves (PSV) for resonance
    - Check off-skid piping and small bore
    - Check that torsional vibration and torsional natural frequencies match the design requirements
    - Inspect pipe clamp installation, shimming, supports, etc.
    - If skid or machinery has high vibration, check foundation. The pile attachment to main skid should be confirmed, especially at interior pile locations. See Figure 3.
    - Spot check fit-up tolerances (based on testing results)
    - Strain gauge (if required)
    - Evaluate interaction between units (if multiple units connected to the same header)
    - Check performance results



Figure 3: Piles Attached to Skid with slip-rings for Saturn 1, 6500 HP KBZ/6 compressor package

c. Comparing field results to the design model

- Check to see if all the design report recommendations have been implemented.
- The field condition may not match data presented in the design report.
  - Results from the design report should be scaled to predict the worst field condition.
  - Operating range analyzed in the original study may have changed – re-running the design model might be helpful to understand any vibration issues. See Figure 4.

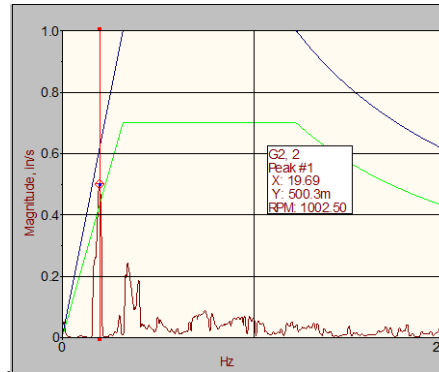

Vibration of scrubber in horizontal direction measured at specific operating condition.

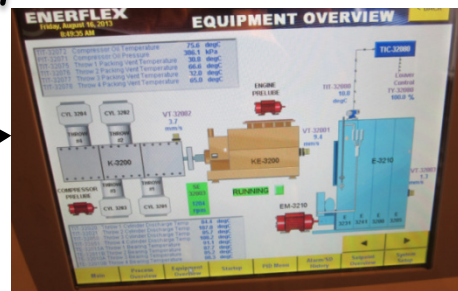

Since vibration is caused by cylinder stretch excitation, the design model and knowledge of cylinder stretch force from design analysis can be used to determine worst case vibration across the operating envelope.

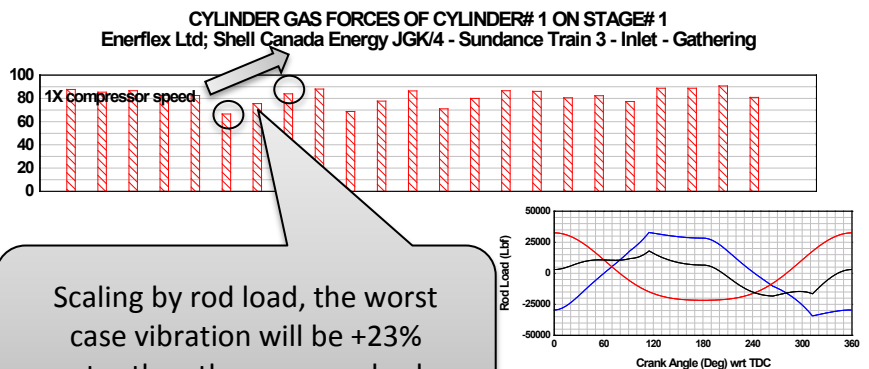
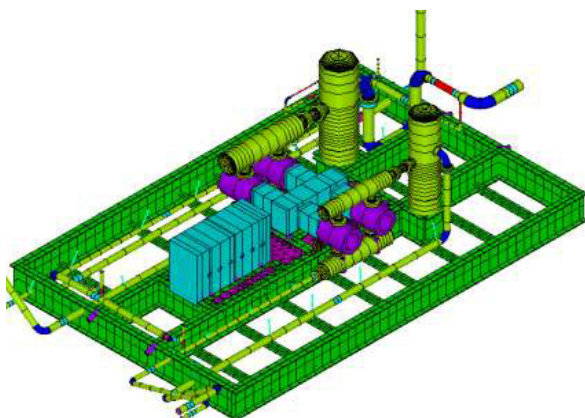

Scaling by rod load, the worst case vibration will be +23% greater than the measured value.

Figure 4: Scaling Vibration Measurement based on Design Analysis



## 2. Piping Tolerances, Fit-up and Field Connections

Field testing has verified that high frequency vibrations are amplified in locations with excessive pipe strain or poor piping installation/fit-up. *For more information and examples of these problems, refer to this GMC Technical Paper: GMC 2013: Piping Misalignment and Vibration Related Fatigue Failures; Gary Maxwell, General Manager, BETA Machinery Analysis; Brian Howes, Chief Engineer, BETA Machinery Analysis. [http://www.betamachinery.com/assets/pdfs/Technical\\_Articles/Piping-Misalignment-Vibration-Related-Fatigue-Failures.pdf](http://www.betamachinery.com/assets/pdfs/Technical_Articles/Piping-Misalignment-Vibration-Related-Fatigue-Failures.pdf)*

Baseline vibration can identify locations where pipe strain is suspected. In severe cases, field modifications may be required to improve the flange or piping alignment. Improved design, shop testing and field connections will avoid these problems.

### Solutions/Improvement Recommendations:

- Design Specifications: alignment standards contained in ASME B31.3 are often not sufficient for key areas of the compressor package, especially in between scrubber and suction bottles. The authors recommend that API 686 be used as the specification for these locations [refer to Chapter 6, section 4-18].
- Shop Connections: if fit-up is done in shop you can get misalignment after transportation and lifting. It is recommended to leave some welds for the field and to make preparations in shop so that this is achievable.
- Field Connections: Shell's experience is that piping field welds at key locations will solve the fit up challenge. Since other field connections are required at site, there is not a significant impact by field welding and hydro-testing a few additional piping spools.

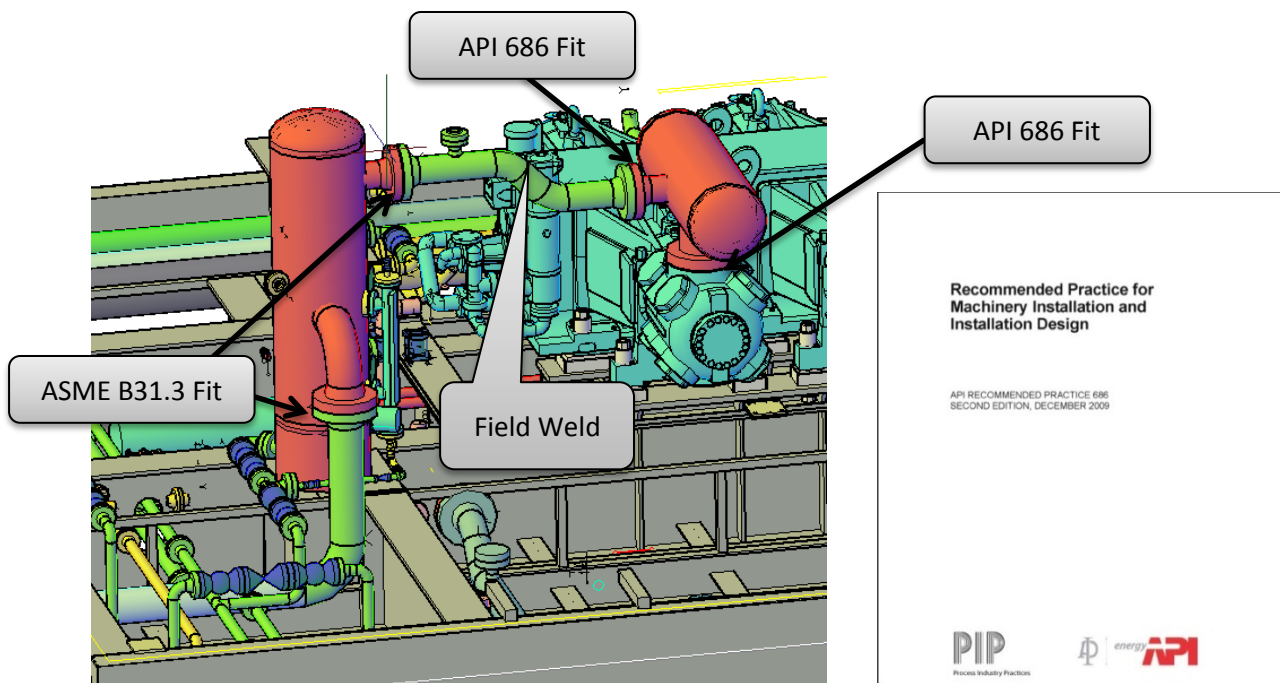

Figure 5: Recommended Alignment Tolerances and Field Welds

Pipe Size (inch)	Angular Gap Tolerance for 300 lb ANSI Class Flanges (inch)	
	ASME B31.3	API 686
2	0.019	0.010
4	0.032	0.011
6	0.044	0.013
10	0.066	0.018
16	0.096	0.026

Figure 6: Angular Gap Tolerance for ASME B31.3 VS. API 686

- d. Post weld heat treating to relieve stress is recommended for nozzle locations, especially with multiple nozzle pulsation bottles.

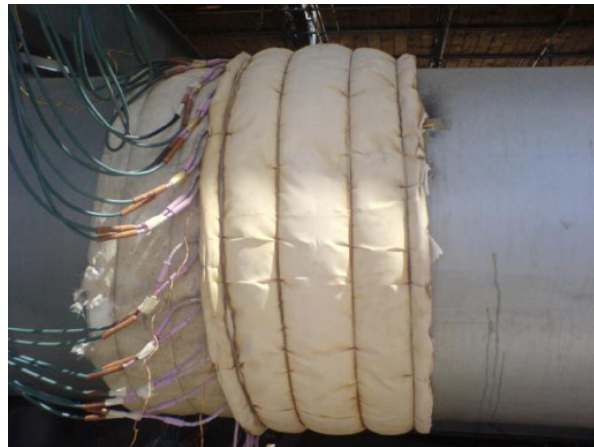

Figure 7: Post Weld Heat Treating to Relieve Stress

- e. Alignment and Fit-up of Multi-cylinder Bottles: The goal is to have flanges in the same plane and not have to individually position the cylinders to suit the bottle.

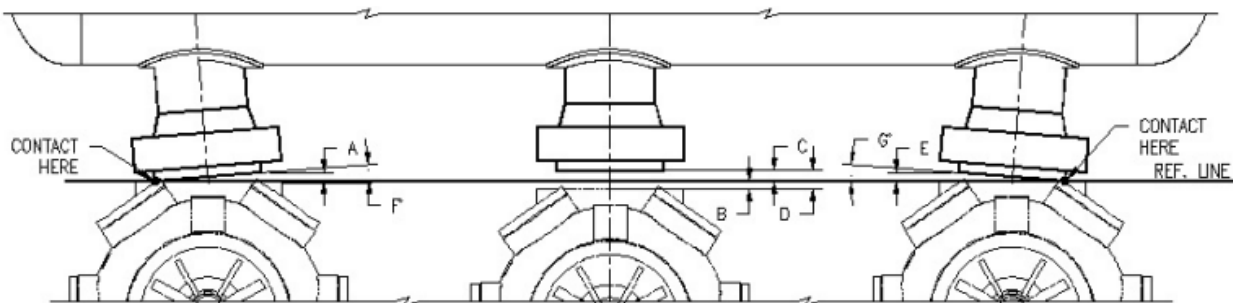
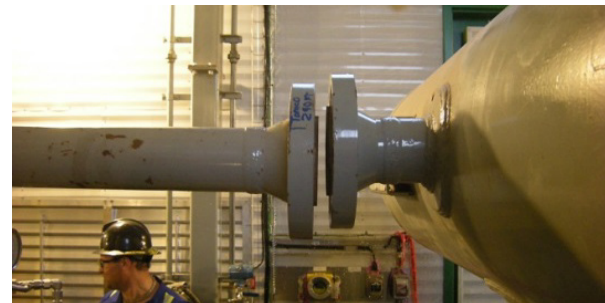

Figure 8: Pictures Illustrating Pipe Misalignment Resulting in Vibration Issues



### 3. Managing Resonance

For most high speed compressors, there is a strong possibility that one or more areas may be resonant. For a compressor operated across a wide speed range, resonance is unavoidable. This means the design team must address the trade-off between resonance, operating speed range, and installation costs.

**Solutions/Improvement Recommendations:**

- a. The challenge is how to best address resonance. Here are some options:
  - Modify the piping system and supports to shift the mechanical natural frequency (MNF) away from resonance. Typically this means increasing the MNF, but sometime the system can be de-tuned. Note in some cases, it may not be feasible / practical to avoid resonance.
  - Avoid resonance by blocking out a speed range – the costs required to operate at the whole speed range may not be worth it, and the whole speed range is likely not necessary.
  - While blocking out a speed range can be the simplest and cheapest solution, it may create concerns from the operating staff. Often these specific concerns can be overcome by alternative operating approaches. Capacity control can be managed by coordination between other units, cylinder loading, the suction control valve, and a recycle valve. The latter two also provide a cost in terms of pressure drop.
  - Add a damping support to reduce resonant vibration amplitude. There is currently a GMRC Research Project in progress to provide information on damping options. See **Evaluation of Dampening Products and Support Designs**. <http://www.gmrc.org/projects>

Test Point	Speed Range												
	600-625	625-650	650-675	675-700	700-725	725-750	750-775	775-800	800-825	825-850	850-890	890-900	
UNIT 2													
2S18	600-650						750-775			800-900			
2S21													
2S21 top valve													

Figure 9: Speeds to Avoid Chart (To Avoid Resonance)

## 4. Compressor Skid Mounting

There are two main ways to support the compressor frame and distance piece supports to the main skid, with the use of grout or machined steel blocks. Also there is the debate as to when to fill the skid base frame with concrete, in the shop or in the field.

When using Grout, the key issues include:

- Selecting the right grout
- Size of grout box
- Differential thermal expansion
- Joint sealing

The following goes over the advantages and disadvantages.

### Solutions/Improvement Recommendations:

- a. Grouting compressors (Frames & Distance Pieces supports) Advantages [A] / Disadvantages [D]
  - A: it can be done quickly in a controlled shop environment.
  - A: for small horsepower applications it is likely sufficient, less weight / forces.
  - D: cracking.
  - D: proper sizing of grout box area is needed to calculate the anticipated deflection. It is not ok to just make box larger by one foot.

*For information and example calculations, refer to the Chockfast Engineering Manual.*  
[http://www2.sintemar.com/documentacion/catalogos/chockfast/prc\\_engineering\\_manual.pdf](http://www2.sintemar.com/documentacion/catalogos/chockfast/prc_engineering_manual.pdf)

  - D: modulus of elasticity of grout vs. steel (Black 800,000 psi vs. 30,000,000 psi carbon steel). If grout is used, selecting the right color grout is important and should be considered in the grout box area calculation.
  - D: if done at site it is difficult to control environmental heat and curing times.
  - D: don't overstress the grout by tightening the bolts too tight.

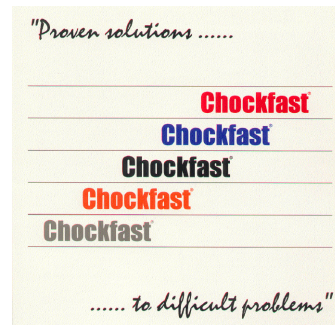

Figure 10: Chockfast Engineering Manual



Figure 11: Grout Box Mount

- b. A “No Grout” alternative – eg. Steel on Steel Supports
- Welded down, and then machine steel blocks. It is important not to weld down pre-machined steel blocks as it defeats the purpose.
  - Very stiff - modulus of elasticity of steel vs. modulus of elasticity of grout (30,000,000 psi carbon steel vs. Black 800,000 psi) .
  - Ability to transfer the load from compressor effectively into piles (as design is intended).
  - More reliable for larger horsepower machines.



Figure 12: Steel Block Mount

- c. When to add concrete to your base frame and why (in the shop vs in the field):
- Costs will depend on a number of factors such as the environment, transportation costs, and time.
    - Adding concrete in the shop:
      - Allows for an easy to control environment for pouring and curing, whereas the site environment may be difficult. The site conditions and the time required for the concrete to cure should be considered.
      - Eliminates additional handling of the compressor at site during construction.
    - Adding concrete in the field/at site:
      - Lower costs to ship the unit.
      - If the site is very remote, pouring concrete may be expensive.
  - Concrete will add mass, stiffness and reduce local deflection of the skid frame during transportation; however, the added mass will increase overall deflection of the skid frame during lifting. A lifting analysis can be done, but this can still cause bending in the piping and supports.
  - If weight is a concern due to shipping requirements it is easy to ship the driver separately.

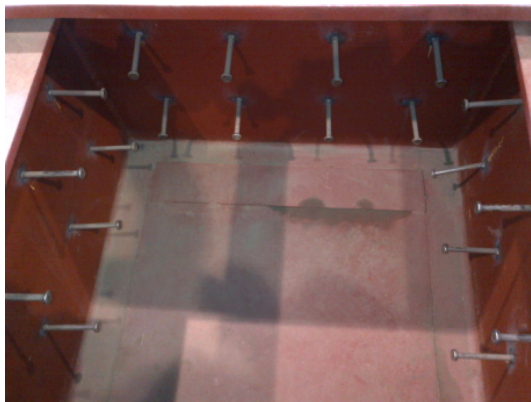

Figure 13: Nelson Studs for Attachment of Concrete

## 5. Small Bore Connections to Suction Scrubbers

More effort is needed to reduce the vibration/integrity risk associated with small bore piping. Refer to these articles and information relating to this design and installation challenge.

<http://www.betamachinery.com/services/small-bore-connections-sbc-assessment>

### Solutions/Improvement Recommendations:

#### a. Design and Fabrication:

- End users involvement is important to address this risk. This includes improved specifications, standards, and inspections.
- Remove, re-design, or re-align are valuable approaches for designers.
- Review design and agree on approach for scrubber attachment, including liquid level controllers.
- Shop inspection and testing is recommended, to avoid resonant problems in the field.
- Avoid threaded connections in vibration services.

**Revision 1 and 2**  
Conventional Site Glass Attachment



**Revision 3**  
Studding Outlets with Site Glass

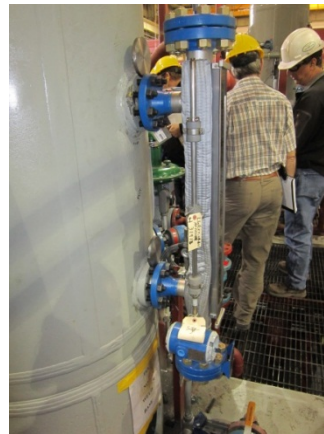

**Revision 4**  
Site Glass Replaced with Ultrasonic Level Switches



**Figure 14: Continuous Improvement of Scrubber Liquid Level Indication**



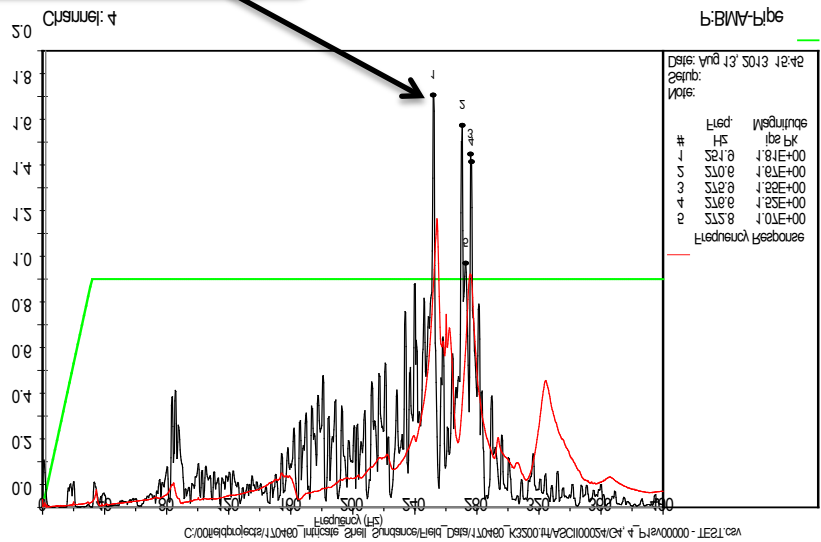
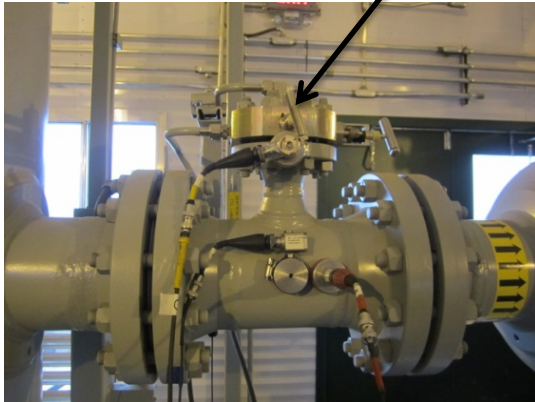

**Figure 15: Robust Small-Bore Attachment Design at Sundance is the Result of Continuous Improvement and Effective End-User Specification.**



- b. Field testing: The scope for the baseline vibration testing and inspection should include small bore piping and connections. Refer to recommended field testing practices. (EFRC paper September 2014: Integrity Evaluation of Small Bore Connections; by Chris Harper, Principal Engineer, Beta Machinery Analysis)

Field Vibration Measurements on a Small-Bore Attachments is 1.8 ips pk @ 252 Hz.



Finite Element Analysis confirms that the maximum allowable vibrations are 2.1 ips pk for this specific small bore geometry, in order to meet allowable stress criteria. Therefore, the field vibration measurement of 1.8 ips pk @ 252 Hz is acceptable.

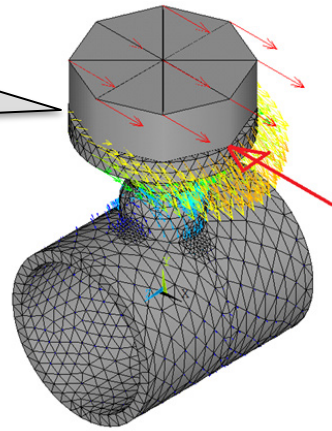

Figure 16: Field Testing of Small Bore Attachments

## 6. Suction Pressure Differential Measurements

Temporary start up screens are very common for commissioning of reciprocating compressor packages. These screens keep debris, and dirt out of the cylinder and path of the piston. As suction screens are wrapped with a fine mesh, plugging off of these screens can occur quickly, and if not detected quickly they can buckle and be pulled into the compressor.



Figure 17: Cone Strainer

### Solutions/Improvement Recommendations:

- a. Permanent Solution: a permanent piping connection tee is made on the suction piping and pulsation bottle on either side of the cone strainer. This solution requires the use of monoflanges and extensive lengths of tubing. Some Advantages [A] and Disadvantages [D] include:
  - D: difficult to properly support tubing that is resonant.
  - D: a permanent connection is not required as differential pressure measurement is only for CSU.
  - A: eliminates the need for threaded fittings in the process gas stream.
  
- b. Temporary Solution: on the flanges on both sides of the cone strainer use tapped flanges. Tapped flanges and flexible tubing to a differential pressure gauge solves a temporary CSU problem and eliminates the need for additional hanging masses.

**Revision 1: Conventional Connection Tee**



**Revision 2: Monoflanges**

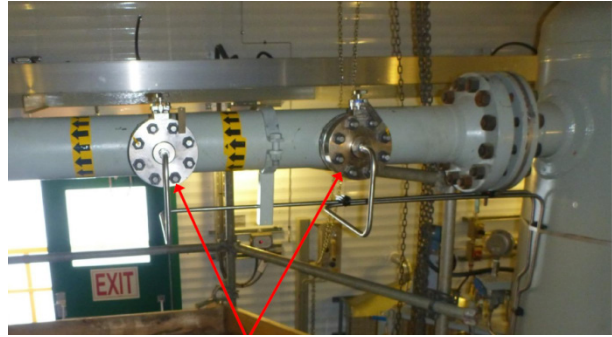

**Revision 3: Using Tapped Flanges for a Temporary Attachment**

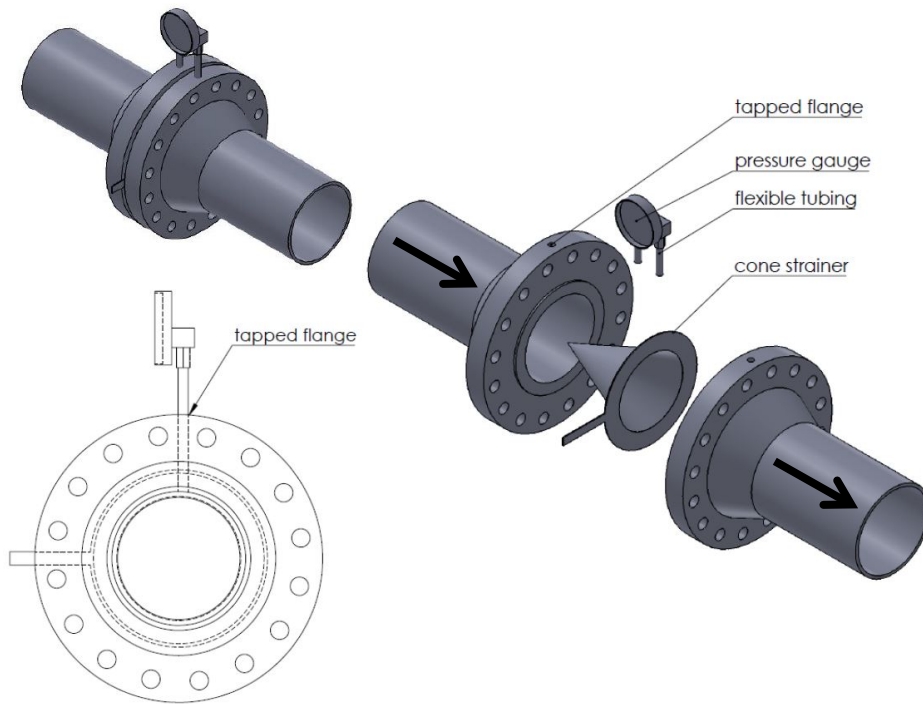

**Figure 18: Continuous Improvement for Pressure Differential Measurements**

## 7. Main Piping and Support Design

There are many options and preferences for piping and support layouts. Improvements in the following areas have reduced vibration risks and provided more robust designs.

### Solutions/Improvement Recommendations:

a. Scrubber to Suction Bottle Piping - There are two common layouts and each has different Advantages [A] and Disadvantages [D] (see pictures).

- Layout 1 – suction piping leaving the scrubber at a different elevation than the suction bottle:
  - D: Higher likelihood of high spool vibration.
  - A: Scrubber more isolated from compressor frame excitation.
  - D: More difficult to align and fabricate, as will likely require a field weld.

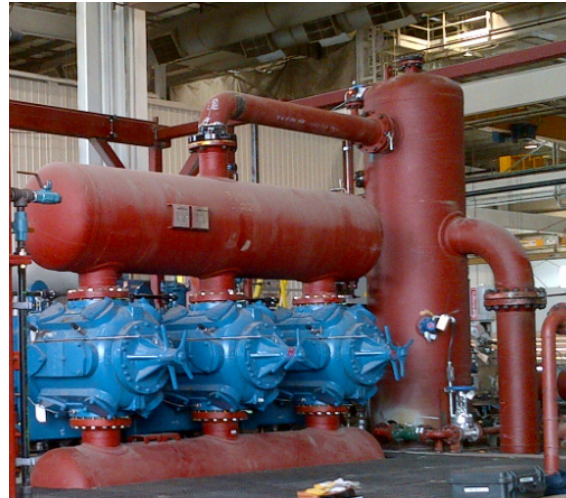

Figure 19: Layout 1

- Layout 2 – suction piping leaving the scrubber in-line with the suction bottle:
  - A: More stiff so resonance with compressor frame excitation likely avoided.
  - D: Scrubber not isolated from compressor frame excitation.
  - A: Easy to fabricate and align.

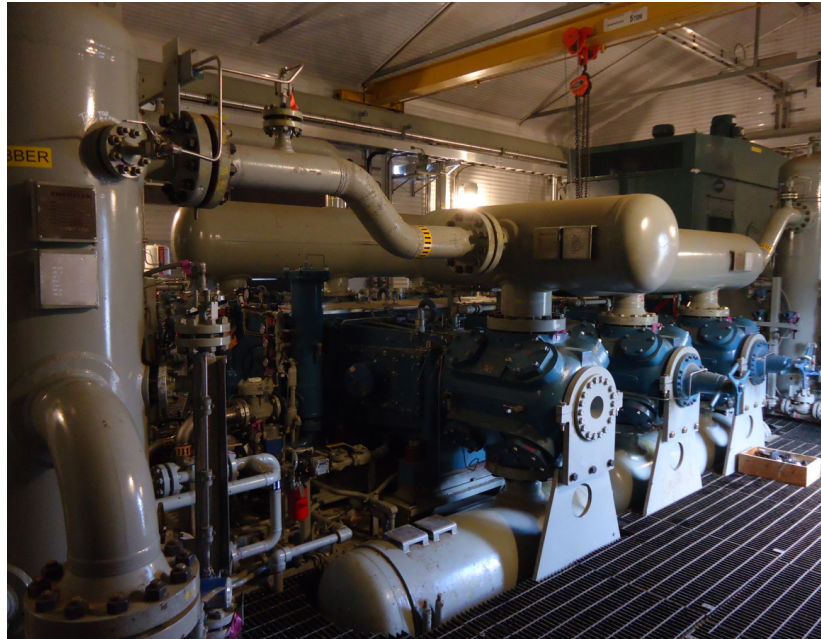

Figure 20: Layout 2



b. Outboard cylinder supports

- The compressor cylinder can sometimes be resonant at certain operating conditions. This can create excessive vibration. Addressing this problem in the field can be challenging, and potentially very expensive.
- During the mechanical analysis, the vibration specialist will identify applications where this resonant risk is likely. The simple solution is to provide provision for a cylinder support:
  - Vibration specialist to provide a proven design that can be field installed.
  - Ensure the skid design includes a beam that can be used to mount the cylinder support.
  - Keep the area underneath the cylinder free of piping.



**Figure 21: Plate-Type Outboard Cylinder Supports**



c. PSV piping

- As the compressor warms up, the discharge piping grows longer due to thermal growth. If the PSV or the flare piping just downstream of the PSV is clamped down tightly, the PSV connection cannot grow with discharge piping, and can become stressed. This has been shown to create pipe strain related failures and excessive vibration.
- The PSV piping design should consider both the thermal and dynamic issues.

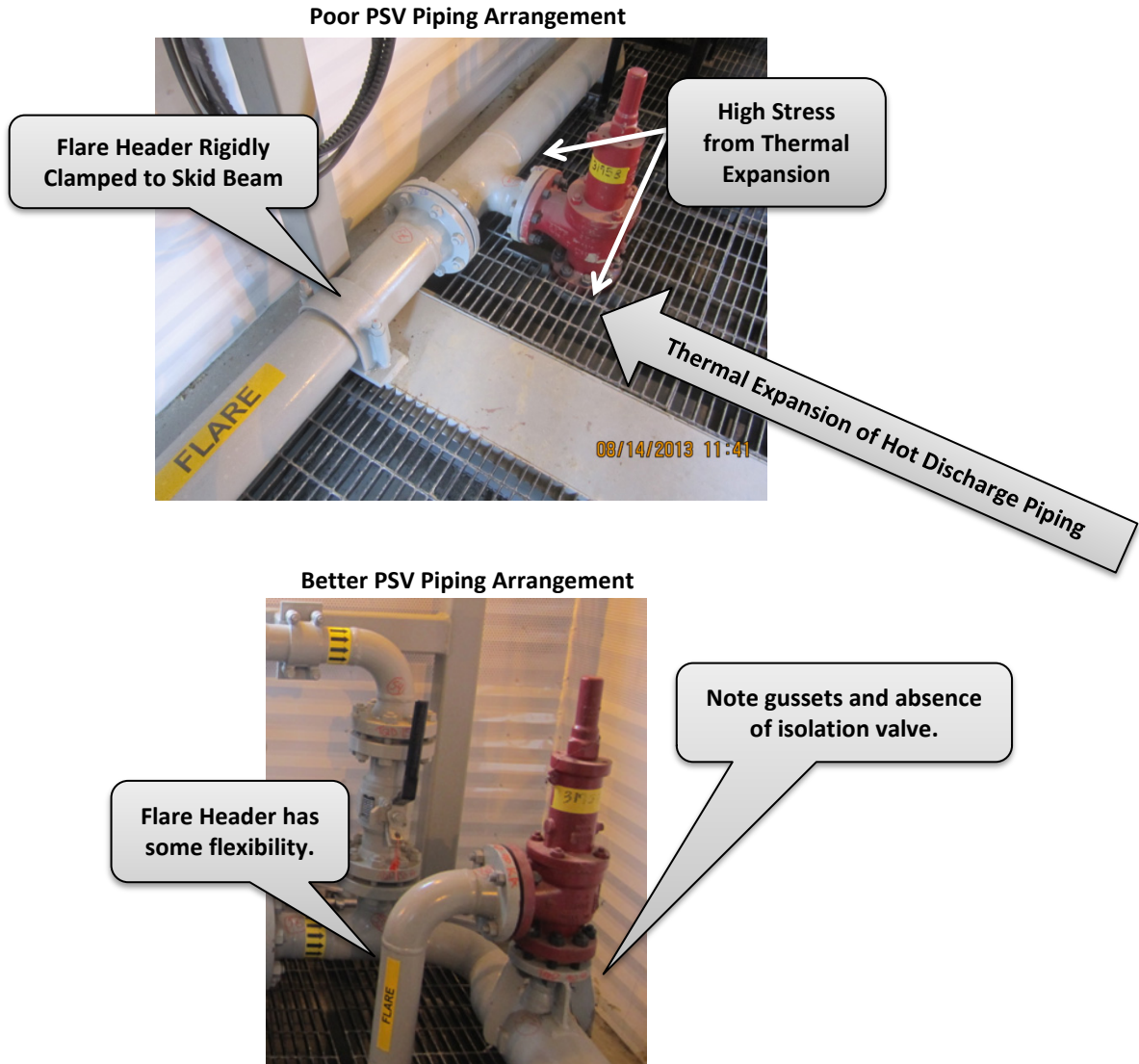
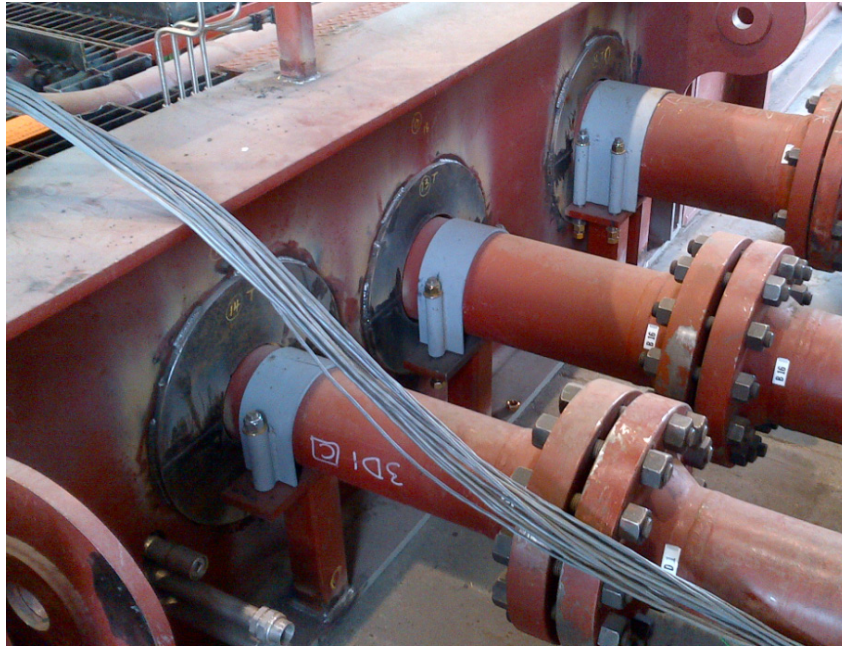

Figure 22: PSV Piping Arrangements

#### d. Piping Clamps for Vibratory Load

- Specialty clamps are available for both vibratory and thermal loads.
- Piping engineers concerned with thermal flexibility often assume that pipe clamps are rigid anchors. This assumption is incorrect and results added flexibility that is not necessary, and can create vibration problems. For information on accurate stiffness and modeling techniques for pipe clamps, see GMRC Research Project **Pipe Support Stiffness**. <http://www.betamachinery.com/wiki/pipe-support-stiffness/>
- Tighten clamps at normal operating temperature.



**Figure 23: Pipe Clamps for Vibratory Service**

#### Conclusion

This paper identifies a number of “lessons learned” from Shell’s recent expansion project in NE British Columbia.

This continuous improvement process requires an effective feedback loop that involves field testing and evaluation. By examining past deficiencies and reliability issues, Shell and its team are able to modify its designs, specifications, inspections, commissioning and project management activities.

The hope is that the ideas and opinions provided in this paper will assist other owners in improving their installations, and will stimulate further industry discussions about best practices.